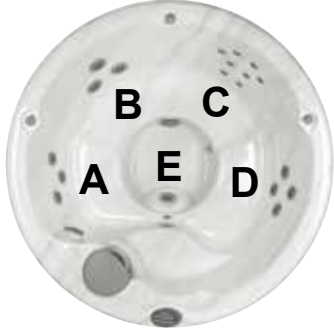

Sundance Spas 680 Denali®

Specifications

Dimensions:	78.5" Round x 36" (200 cm Round x 91.5 cm)	
Seating Capacity:	4 Adults	
Dry Weight:	560 lbs (254 kg)	
Filled Weight (Spa Volume):	3,062 lbs (1,389 kg)	
Filled Weight (Average Fill):	2,562 lbs (1,162 kg)	
Water Capacity (Spa Volume):	300 US Gal (1,136 Liters)	
Water Capacity (Average Fill):	240 US Gal (908 Liters)	
Controls:	Solid-State Electronic Controls with LCD Readout, Programmable Water Temperature, Filtration, and Heat Cycles	
Water Delivery:	1 High Flow Pump	
Pump 1:	North America (60 Hz): 1.5 HP/2-Speed Continuous, 11.0A max., 48 Frame Export (50 Hz): 2.0 HP/2-Speed Continuous, 8.0A max.	
Total Hydrojets:	20	<p>Textured Jets are standard. Stainless Steel is an option.</p>
Seat A Jets:	3 DXL	
Seat B Jets:	3 DVX	
Seat C Jets:	8 DX	
Seat D Jets:	4 DXL	
Footwell Jet (E):	1 DVX	
Divert-A-Jet:	1	
Air Controls/Massage Selectors: ...	3 Air Controls; No Massage Selectors	
Filter:	50 ft ² Filter Cartridge System	
Water Treatment:	Factory installed CLEARRAY® Water Purification System	
Lighting:	SunGlow Multi-Color LED Light	
Synthetic Cabinet:	Available in Coastal, Mahogany, Autumn Walnut	
Shell Colors:	North America: Platinum, Celestite (Gypsum), Sahara, Oyster (Opal), Copper Sand, Monaco, Midnight, Caribbean Surf, Sandstone, Porcelain Export (50 Hz): All North American colors	
Heater:	North America (60 Hz): High-Flow, 1 kW@120 VAC or Convertible to 4 kW@240 VAC; Export (50 Hz): High-Flow, 2.7 kW	
Electrical Requirements:	North America Convertible Model (60 Hz): 120 VAC@15A with Supplied GFCI Cord or 240 VAC@30A or 40A (Hard Wired Only); Export (50 Hz): 230-240 VAC@1x20A or 2x16A (see manual for more configurations); or Suitably Rated Circuit Breaker to Comply with Local Electrical Regulations. Certain Countries May Require 2 Power Inputs; Two GFCI/RCD Breakers are Required for This Configuration.	
Limited Warranty*:	North America (60 Hz): 5 Years Shell, 3 Years Shell Surface, 3 Years Plumbing Component Leaks, 3 Years Equipment and Controls, 1 Year Cabinet, 1 Year Jets Export (50 Hz): 5 Years Shell, 3 Years Shell Surface, 3 Years Plumbing Component Leaks, 3 Years Equipment and Controls, 1 Year Cabinet, 1 Year Jets	
Audio System (Optional):	Audio System Not Offered on This Model	
Special Features:	Factory Installed SmartTub™ module	

*(See Warranty Document for Specific Details)

Dimensions/Specifications Subject To Change Without Notice

Sundance Spas 680 Denali

Operation/Seat Depths

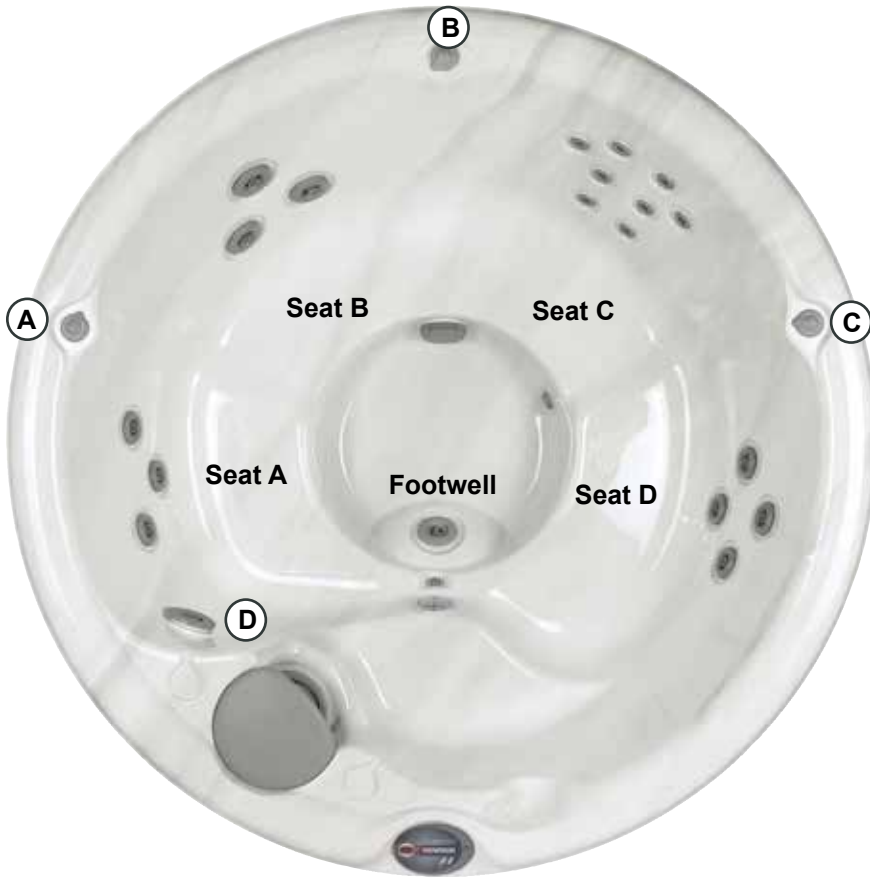

- (A)** Air Control - Activates the Divert-A-Jet (D)
- (B)** Air Control - Activates Seat A Jets (3 DXL), Seat B Jets (3 DVX), Seat D Jets (4 DXL)
- (C)** Air Control - Activates Seat C Jets (8 DX) and Footwell Jet (1 DVX)
- (D)** Divert-A-Jet - Adjusts Massage Levels Between itself and Seat A Jets + Seat B Jets + Seat D Jets

Seat C Jets + All Footwell Jets are on all the time when the jets pump is running.

20 Total Jets



DX Jets (8)



DXL Jets (7)



DVX Jet (4)



Divert-A-Jet (1)

Spa Operation Subject To Change Without Notice

SEAT DEPTHS

- A = 24.75" (62.87 cm)**
- B = 26.75" (67.95 cm)**
- C = 26.75" (67.95 cm)**
- D = 26.75" (67.95 cm)**
- E = 17.00" (43.18 cm)**
- F = 32.00" (81.28 cm)**

Listed dimensions represent distance from top of acrylic to lowest point in seat. **Tolerance ± 0.5" (1.27 cm).**



Dimensions/Specifications Subject To Change Without Notice

Sundance Spas 680 Denali

Portable Dimensions

TOP VIEW

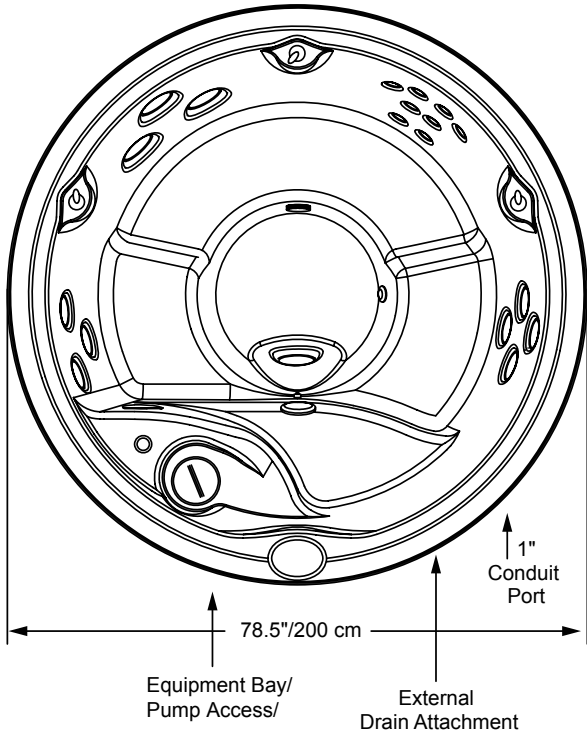

FRONT VIEW

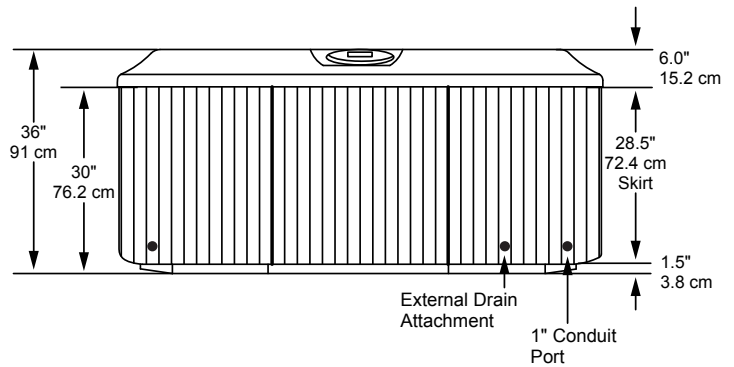

BACK/SIDE VIEW

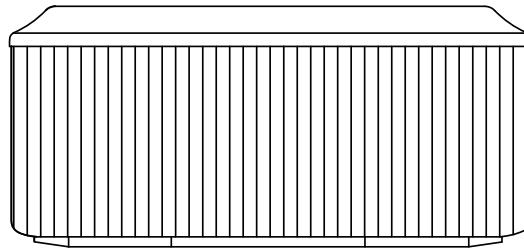

IMPORTANT! Always measure each hot tub for exact dimensions BEFORE designing its foundational support and/or decking.



BOTTOM VIEW

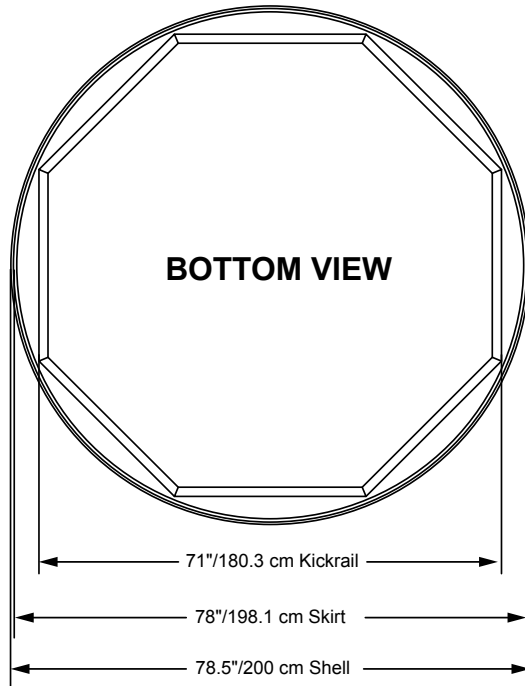

Dimensions/Specifications Subject To Change Without Notice

Denne modellen kan kobles med 1-fas 230V C-sikring

680-serien:

Denali:	For å få mest mulig glede av badet anbefaler vi høyeste kurs for optimal drift.			
	Type varmeelement	Alternativ tilkobling	Funksjon	Kretskortinnstillinger
Denali	5,5 kW	32 amp eller 10 + 25 amp	Varmeelement og pumper kan brukes samtidig	Se brukermanual.
Denali	2,7 kW	20 amp eller 13 + 10 amp	Varmeelement og pumper kan brukes samtidig	Se brukermanual.
Denali	2,7 kW	16 amp	Varmeelementet slår seg av når pumpene settes på høy hastighet.	Se brukermanual.