

Sundance® Spas 980 Kingston™

Specifications

Dimensions:	92" x 100" x 34" (233.7 cm x 254 cm x 86.4 cm)	
Seating Capacity:	6-7 Adults	
Dry Weight:	1,048 lbs (475 kg)	
Filled Weight (Spa Volume):	5,310 lbs (2,408 kg)	
Filled Weight (Average Fill):	4,392 lbs (1,992 kg)	
Water Capacity (Spa Volume):	511 US Gal (1,934 Liters)	
Water Capacity (Average Fill):	401 US Gal (1,518 Liters)	
Controls:	980 iTouch™ Glass Interface LCD Control, Displays Temperature, Time, Cycles and Jet/Air System Control. Offers Customizing of Filtration Cycles, Lighting, Water Temperature Setting and other features	
Water Delivery:	3 TheraMax High-Flow Pumps and 8-Hour Dynamic Flow Circulation System	
Pump 1:	North America (60 Hz): 1-Speed/2.5 HP Continuous, 11.3A Max., 56 Frame Export (50 Hz): 1-Speed/2.0 HP Continuous, 7A Max.	
Pump 2:	North America (60 Hz): 1-Speed/2.5 HP Continuous, 11.3A Max., 56 Frame Export (50 Hz): 1-Speed/2.0 HP Continuous, 7A Max.	
Pump 3:	North America (60 Hz): 1-Speed/2.5 HP Continuous, 11.3A Max., 56 Frame Export (50 Hz): 1-Speed/2.0 HP Continuous, 7A Max.	
Pump 4:	High-Output Dynamic Flow, 8-Hour Filter/Circulation Pump (35 gpm) Programmable for Daily Start Time and Duration	
Total Hydrojets:	57	
Seat A Jets:	6 Fluidix Reflex	
Seat B Jets:	4 Fluidix Reflex	
Seat C Jets:	12 Fluidix-ST, 2 Fluidix Nex, 2 Pulsator, 2 Accu-Pressure	
Seat D Jets:	1 Vortex	
Seat E Jets:	2 Fluidix Nex, 4 Fluidix Reflex, 2 Fluidix Intelli-Jet, 2 Pulsator, 2 Accu-Pressure	
Seat F Jets:	2 Vortex	
Seat G Jets:	4 Vortex	
Footwell Jets (H):	8 Accu-Pressure, 1 Accu-Pressure (sidewall), 1 Vortex	
Air Blower:	High-efficiency, 1-Speed	
Aromatherapy Delivery:	12 Silent Air® Injector Jets with Quiet High Speed Air Pump	
Air Controls/Massage Selectors:	4/2	
Filter:	MicroClean® Ultra Filtration System, 130 ft ² (2 interlocking cartridge filters)	
Water Treatment:	Automatic Brominator and Dynamic Flow Circulation System; Factory installed CLEARRAY® Water Purification System and CLEARRAY® PRO ₃ TECT™	
Lighting:	Multicolored LED Lighting System (1 Waterfall, 1 Footwell), Exterior Corner Lights, SunCooler Bin Lights, Seat Accent Lights	
Synthetic Cabinet:	Available in Coastal, Mahogany	
Shell Colors:	Platinum, Celestite (Gypsum), Sahara, Monaco, Porcelain, Midnight	
Headrests:	4	
Heater:	Low Flow 5.5 kW With Titanium Element Export (50 Hz): Low Flow 2.7 kW with Titanium Element	
Electrical Requirements:	North America (60 Hz): 240 VAC@40A/50A or 60A; Export (50 Hz): 230-240 VAC@1x20A, 1x16A/1x20A, 3x16A (see manual for more configurations); or Suitable Rated Circuit Breaker To Comply With Local Electrical Regulations. Certain Countries May Require 2 Power Inputs; Two GFCI/RCD Breakers are Required For This Configuration.	
Limited Warranty*:	North America (60 Hz): 10 Years Shell, 7 Years Shell Surface, 5 Years Plumbing Component Leaks, 5 Years Equipment and Controls, 5 Years Cabinet, 5 Years Jets, 2 Years Lights, 1 Year Stereo Export (50 Hz): 10 Years Shell, 7 Years Shell Surface, 5 Years Plumbing Component Leaks, 5 Years Equipment and Controls, 5 Years Cabinet, 5 Years Jets, 2 Years Lights, 2 Years Stereo	
Waterfall Feature:	Adjustable Flow Rate; Colored Lighting	
Audio System (Optional):	Factory Installed BLUEWAVE® 2.0 Wireless Spa Stereo System with Auxiliary 3.5 mm headphone jack connection, Bluetooth® compatible, 4 premium speakers and a powered subwoofer	
Special Features:	Factory Installed SmartTub™ module	

*(See Warranty Document for Specific Details)

Dimensions/Specifications Subject To Change Without Notice

Sundance Spas 980 Kingston

Operation/Seat Depths

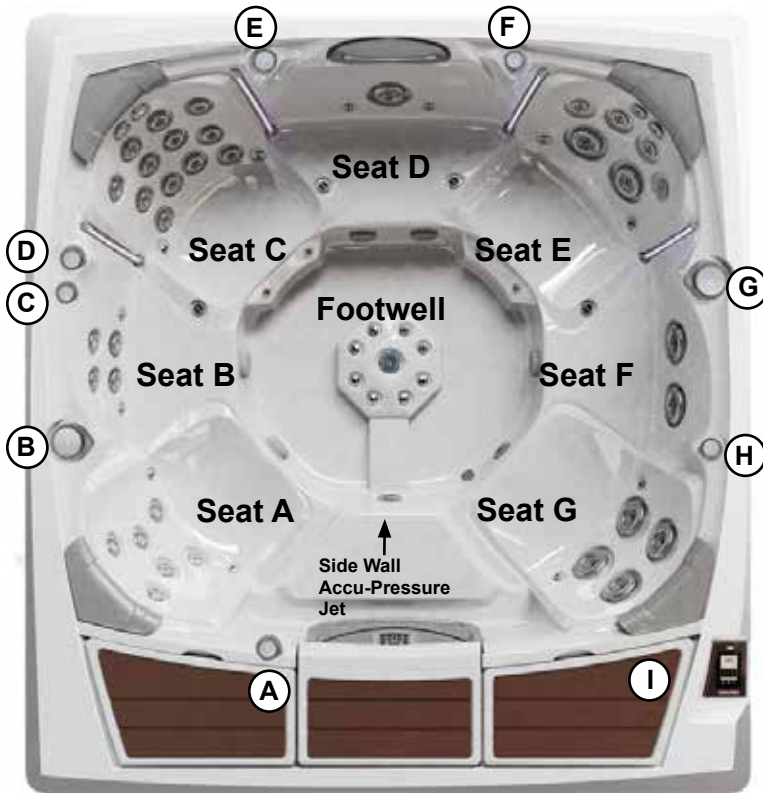

- (A)** Air Control - Activates Seat A Jets (6 Fluidix Reflex), Seat B Jets (4 Fluidix Reflex), Seat F Jets (2 Vortex), Seat D Jets (1 Vortex), and Footwell (2 Accu-Pressure, 1 Vortex) - Also used when draining the SunCooler Bins in the close position.
- (B)** Massage Selector [Pump 2] - Adjusts Massage Level Between Seat A Jets + 2 Footwell (2 Accu-Pressure) and Seat B Jets (2 Lower Fluidix Reflex) + Seat D Jets + Seat F Jets
- (C)** AccuSage Seat Valve - Adjusts Water Flow for Seat C (2 Fluidix Nex, 12 Fluidix-ST, 2 Accu-Pressure Jets, 2 Pulsators) + Footwell (2 Accu-Pressure)
- (D)** Air Control - Activates Seat C Jets (2 Fluidix Nex, 12 Fluidix Reflex, 2 Pulsators, 2 Accu-Pressure) and Footwell (2 Accu-Pressure)
- (E)** Waterfall Selector [8-Hour Circ. Pump] - Controls Waterfall Output
- (F)** Air Control - Activates Seat E Jets (2 Fluidix Nex, 4 Fluidix Reflex, 2 Fluidix Intelli-Jet, 2 Pulsators, 2 Accu-Pressure) and Footwell (2 Accu-Pressure)
- (G)** Massage Selector [Pump 1] - Adjusts Massage Level Between the Seat E Jets + Seat G Jets and Footwell (2 Accu-Pressure) + Footwell (2 Accu-Pressure)
- (H)** Air Control - Activates Seat G Jets (4 Vortex) and Footwell (2 Accu-Pressure)

57 Total Jets

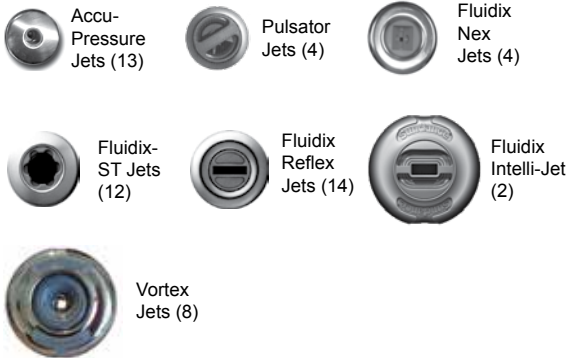

- (I)** SunScents Dispenser
- Jets Pump 3: Seat C Jets + 2 Footwell Jets (2 Accu-Pressure)
- Jets Pump 2: Seat B (2 Upper Fluidix Reflex Jets) + Center Footwell Jet (1 Vortex) are always on when this pump is running.
- Jets Pump 1: Footwell Upper Right (2 Accu-Pressure Jets) + 1 Accu-Pressure Jet (Side Wall) in Footwell and SunCooler Perimeter Drains are always on when this pump is running.

Spa Operation Subject To Change Without Notice

SEAT DEPTHS

A = 23.25" (59.01 cm)	G = 22.00" (55.88 cm)
B = 21.00" (53.34 cm)	H = 17.00" (43.18 cm)
C = 26.00" (66.04 cm)	I = 29.25" (74.30 cm)
D = 20.50" (52.07 cm)	
E = 24.25" (61.60 cm)	SunCooler Bin Depth
F = 20.00" (50.80 cm)	J = 13.50" (34.29 cm)

Listed dimensions represent distance from top of acrylic to lowest point in seat. **Tolerance ± 0.5" (1.27 cm).**

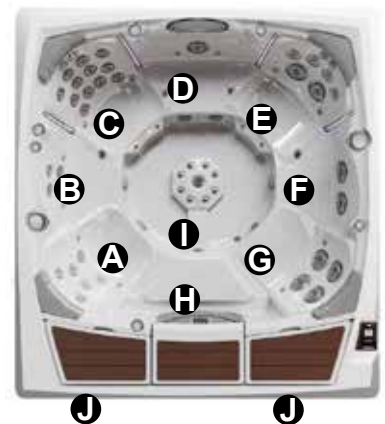

Dimensions/Specifications Subject To Change Without Notice

Sundance Spas 980 Kingston

Portable Dimensions

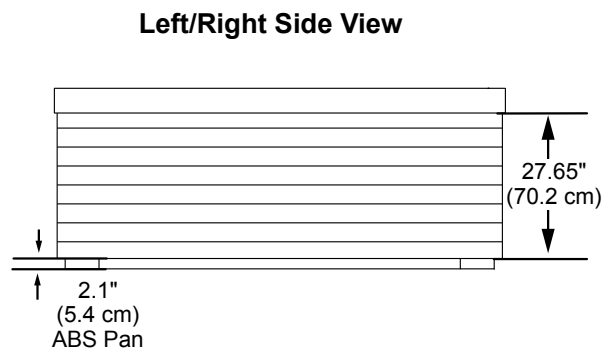
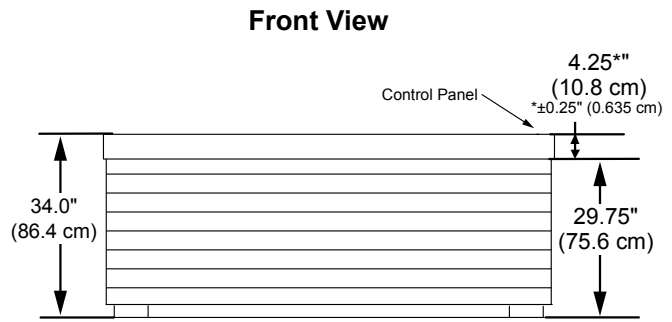
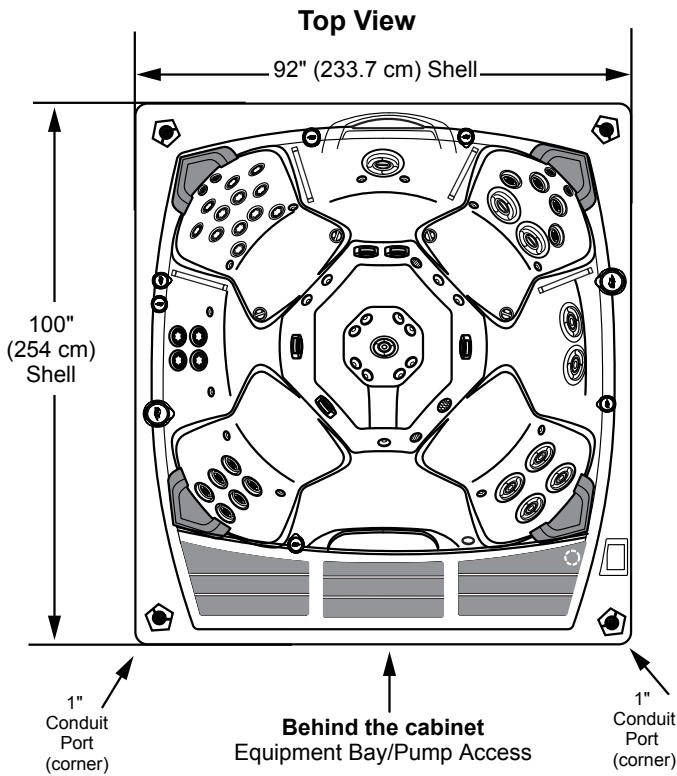

IMPORTANT! Always measure each hot tub for exact dimensions BEFORE designing its foundational support and/or decking.

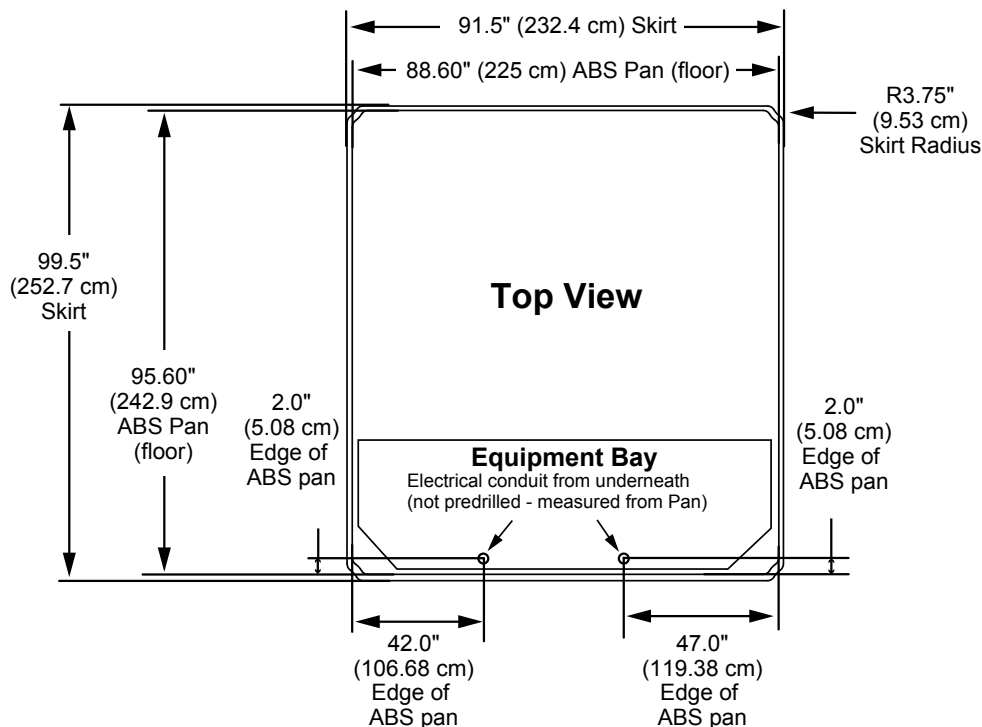

Dimensions/specifications subject to change without notice. Tolerance: ± 0.5" (1.27 cm)

Dimensions/Specifications Subject To Change Without Notice

Denne modellen kan kobles med 1-fas 230V C-sikring (treg) og 3-fas (400 volt TN-nett - se egne linjer)

980-serien:

Kingston	For å få mest mulig glede av badet anbefaler vi høyeste kurs for optimal drift.			
	Type varmeelement	Alternativ tilkobling	Funksjon	Kretskortinnstillinger
Kingston	5,5 kW	3-fas (400 volt TN-nett) 25 amp	Varmeelement og pumper kan brukes samtidig	Se brukermanual.
Kingston	5,5 kW	25 + 32 amp	Varmeelement og pumper kan brukes samtidig	Se brukermanual.
Kingston	5,5 kW	40 amp	Alle pumper kan brukes samtidig. Varmeelementet og 2 pumper kan brukes samtidig.	Se brukermanual.
Kingston	2,7 kW	3-fas (400 volt TN-nett) 16 amp	Varmeelement og pumper kan brukes samtidig	Se brukermanual.
Kingston	2,7 kW	40 amp eller 16 + 32 amp	Varmeelement og pumper kan brukes samtidig	Se brukermanual.
Kingston	2,7 kW	32 amp	Alle pumper kan brukes samtidig. Varmeelementet slår seg automatisk av når en av pumpene startes.	Se brukermanual.