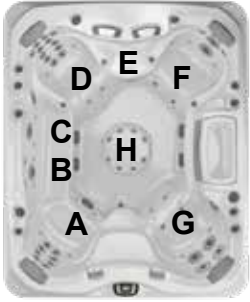

Sundance® Spas 880 Aspen®

Specifications

Dimensions:	91" x 110" x 41.5" (231.14 cm x 279.4 cm x 105.41 cm)	
Perimeter:	402" (1021.1 cm)	
Seating Capacity:	7-8 Adults	
Dry Weight:	1,154 lbs (523 kg)	
Filled Weight (Spa Volume):	6,784 lbs (3,077 kg)	
Filled Weight (Average Fill):	5,491 lbs (2,491 kg)	
Water Capacity (Spa Volume):	675 US Gal (2,555 Liters)	
Water Capacity (Average Fill):	520 US Gal (1,968 Liters)	
Controls:	880 iTouch Interface LCD Control, Displays Temperature, Time, Cycles and Jet/Air System Control. Offers Customizing of Filtration Cycles, Lighting, Water Temperature Setting and other features	
Water Delivery:	3 TheraMax High-Flow Pumps and 8-Hour Dynamic Flow Circulation System	
Pump 1:	North America (60 Hz): 1-Speed/2.5 HP Continuous, 11.3A Max., 56 Frame Export (50 Hz): 1-Speed/2.0 HP Continuous, 7A Max.	
Pump 2:	North America (60 Hz): 1-Speed/2.5 HP Continuous, 11.3A Max., 56 Frame Export (50 Hz): 1-Speed/2.0 HP Continuous, 7A Max.	
Pump 3:	North America (60 Hz): 1-Speed/2.5 HP Continuous, 11.3A Max., 56 Frame Export (50 Hz): 1-Speed/2.0 HP Continuous, 7A Max.	
Pump 4:	High-Output Dynamic Flow, 8-Hour Filter/Circulation Pump (35 gpm) Programmable for Daily Start Time and Duration	
Total Hydrojets:	66	
Seat A Jets:	2 Fluidix Nex, 8 Fluidix Reflex	
Seat B Jets:	2 Fluidix Reflex, 1 Fluidix Intelli-Jet	
Seat C Jets:	1 Fluidix Intelli-Jet	
Seat D Jets:	2 Fluidix Nex, 12 Fluidix ST, 2 Pulsator, 2 Accu-Pressure, 1 Whirlpool (sidewall)	
Seat E Jets:	2 Fluidix Reflex	
Seat F Jets:	2 Fluidix Nex, 2 Fluidix Reflex, 2 Fluidix Intelli-Jet, 2 Pulsator, 4 Accu-Pressure	
Seat G Jets:	2 Fluidix Nex, 2 Vortex, 2 Fluidix Intelli-Jet, 4 Accu-Pressure, 1 Whirlpool (sidewall)	
Footwell Jets (H):	8 Accu-Pressure	
Air Blower:	High-efficiency, 1-Speed	
Aromatherapy Delivery:	14 Silent Air® Injector Jets with Quiet High Speed Air Pump	
Air Controls/Massage Selectors:	8/2 (Standard air control with LED lights and massage selector with LED lights)	
Filter:	MicroClean® Ultra Filtration System, 130 ft² (2 interlocking cartridge filters)	
Water Treatment:	Automatic Brominator and Dynamic Flow Circulation System; Factory installed CLEARRAY Active Oxygen™ Clear Water System	
Lighting:	Multicolored Sunglow LED Lighting System (2 Waterfall, 2 Footwell, 8 Air controls, 2 Massage Selectors, 2 Backlit handrails, Exterior lights)	
Skirt Cabinet (SunSide™):	Modern Hardwood, Brushed Gray and Vintage Oak (Equipped with Standard Exterior Lights)	
Shell Colors:	Platinum, Celestite (Gypsum), Monaco, Midnight, Porcelain	
Handrails:	Two High Quality Stainless Steel with backlit LED lighting	
ComfortTone Headrests:	Four, 1-Piece Gray	
Heater:	Low Flow 5.5 kW With Titanium Element Export (50 Hz): Low Flow 5.5 kW with Titanium Element	
Electrical Requirements:	North America (60 Hz): 240 VAC@50A or 60A; Export (50 Hz): 230-240 VAC@1x40A, 2x25A, 1x25A/1x32A (see manual for more configurations); or Suitable Rated Circuit Breaker To Comply With Local Electrical Regulations. Certain Countries May Require 2 Power Inputs; Two GFCI/RCD Breakers are Required For This Configuration.	
Limited Warranty*:	North America (60 Hz): 10 Years Shell, 7 Years Shell Surface, 5 Years Plumbing Component Leaks, 5 Years Equipment and Controls, 5 Years Cabinet, 5 Years Jets, 2 Years Lights, 1 Year Stereo Export (50 Hz): 10 Years Shell, 7 Years Shell Surface, 5 Years Plumbing Component Leaks, 5 Years Equipment and Controls, 5 Years Cabinet, 5 Years Jets, 2 Years Lights, 2 Years Stereo	
Waterfall Feature:	Adjustable Flow Rate; Colored Lighting	
Audio System (Optional):	Factory Installed BLUEWAVE® 2.0 Wireless Spa Stereo System with Auxiliary 3.5 mm headphone jack connection, Bluetooth® compatible, 4 premium speakers and a powered subwoofer	
Special Features:	MicroClean® Plus Versatile Filter Lid, Optional Filter Lid Pillow seat, Optional (Factory Installed) SmartTub™ Module	

*(See Warranty Document for Specific Details)

Dimensions/Specifications Subject To Change Without Notice

Sundance Spas 880 Aspen

Operation/Seat Depths

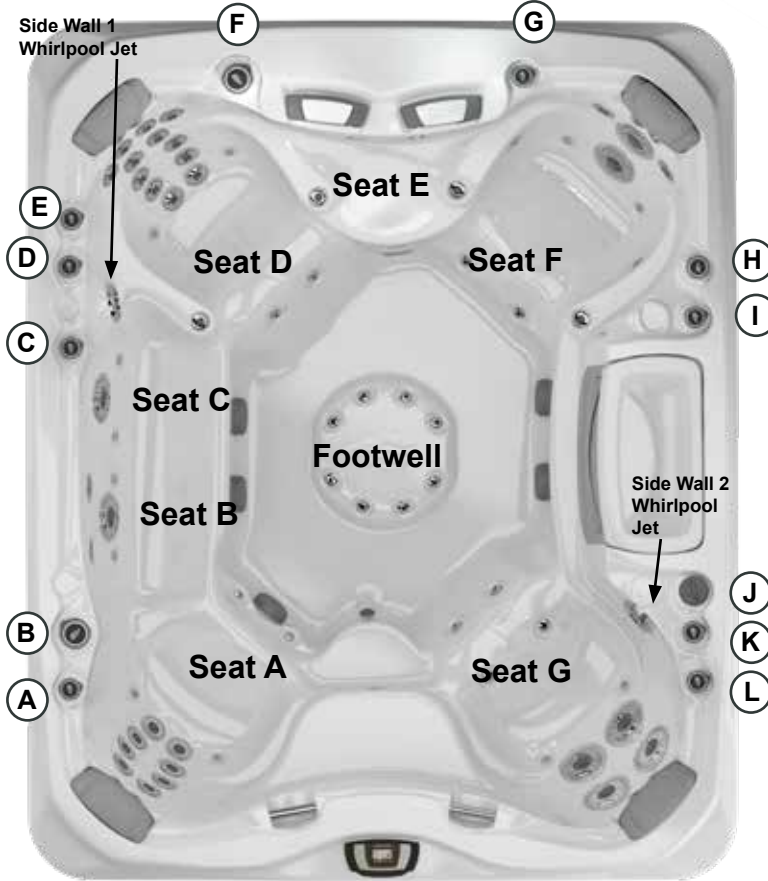

- (A)** Air Control - Activates Seat A Jets (2 Fluidix Nex, 8 Fluidix Reflex), Seat B Jets (2 Fluidix Reflex, 1 Fluidix Intelli-Jet) and Seat C Jet (1 Fluidix Intelli-Jet)
- (B)** Massage Selector [Pump 1] - Adjusts Massage Level Between Seat A Jets + Seat B Jets + Seat C Jets and both Side Wall Whirlpool Jets
- (C)** Air Control - Activates Side Wall 1 Whirlpool Jet
- (D)** Air Control - Activates Lower Seat D Jets (6 Fluidix-ST, 2 Pulsators, 2 Accu-Pressure)
- (E)** Air Control - Activates Upper Seat D Jets (2 Fluidix Nex, 6 Fluidix-ST)
- (F)** Massage Selector [Pump 2] - Adjusts Massage Level Between Seat D Jets and Seat G Jets
- (G)** Air Control - Activates Seat E (2 Fluidix Reflex) + Seat F Jets (2 Fluidix Nex, 2 Fluidix Reflex, 2 Fluidix Intelli-Jets, 2 Pulsators, 4 Accu-Pressure)
- (H)** Waterfall Selector [8-Hour Circ. Pump] - Controls Waterfall Output
- (I)** Air Control - Activates Center Footwell Jets (8 Accu-Pressure)
- (J)** SunScents Dispenser
- (K)** Air Control - Activates Side Wall 2 Whirlpool Jet
- (L)** Air Control - Activates Seat G Jets (2 Fluidix Nex, 2 Vortex, 2 Fluidix Intelli-Jet, 4 Accu-Pressure)

66 Total Jets



- Jets Pump 3: Seat E Jets, Seat F Jets and Footwell Jets are always on when this pump is running

Spa Operation Subject To Change Without Notice

SEAT DEPTHS

- A = 26.50" (67.31 cm)**
- B = 26.00" (66.04 cm)**
- C = 26.00" (66.04 cm)**
- D = 27.63" (70.15 cm)**
- E = 21.38" (54.31 cm)**
- F = 26.50" (67.31 cm)**
- G = 25.75" (65.41 cm)**
- H = 16.38" (41.61 cm)**
- I = 36.00" (91.44 cm)**

Listed dimensions represent distance from top of acrylic to lowest point in seat. **Tolerance ± 0.5" (1.27 cm).**

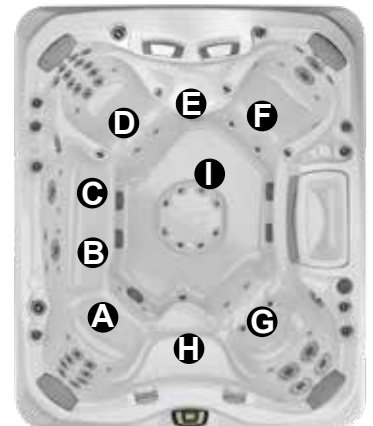

Dimensions/Specifications Subject To Change Without Notice

Sundance Spas 880 Aspen

Portable Dimensions

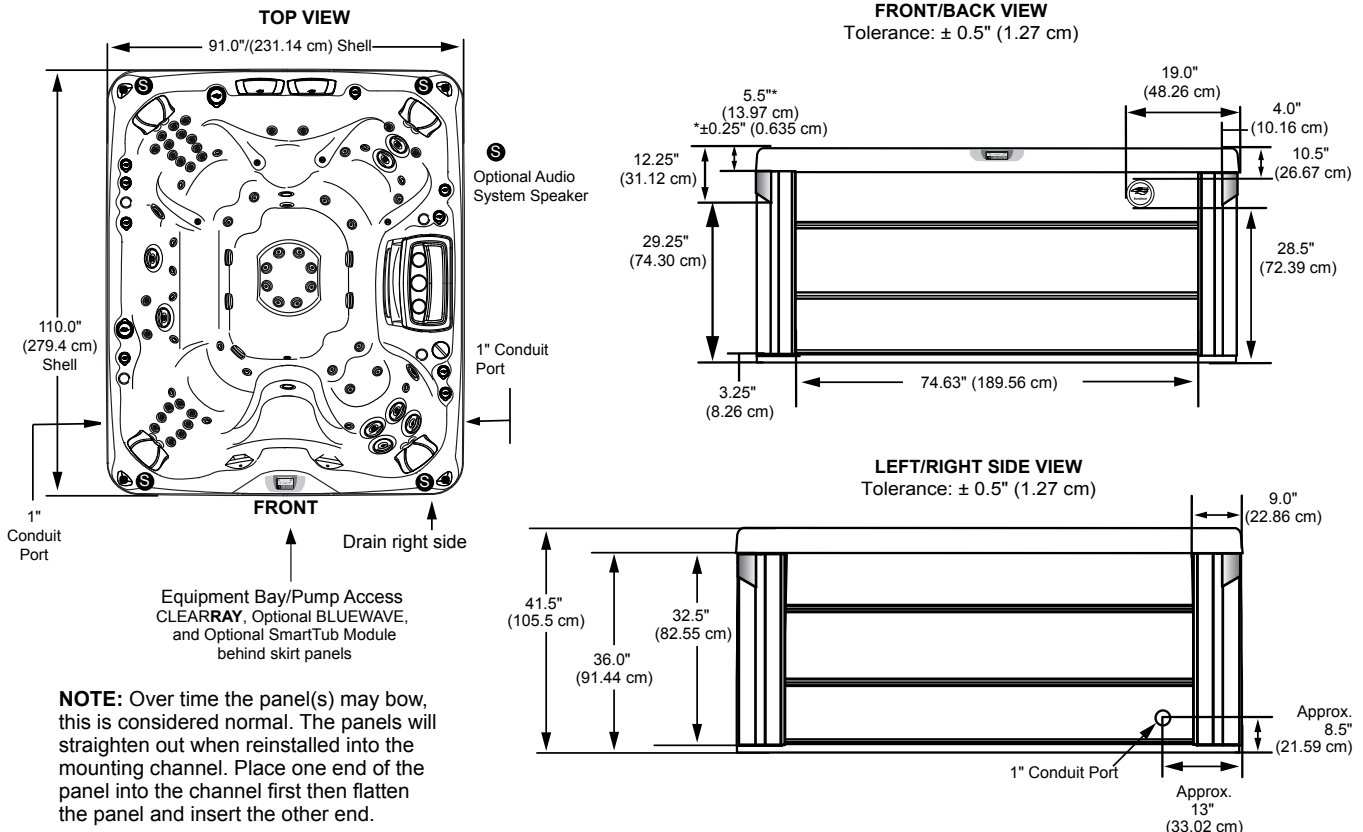

IMPORTANT! Always measure each hot tub for exact dimensions **BEFORE** designing its foundational support and/or decking.

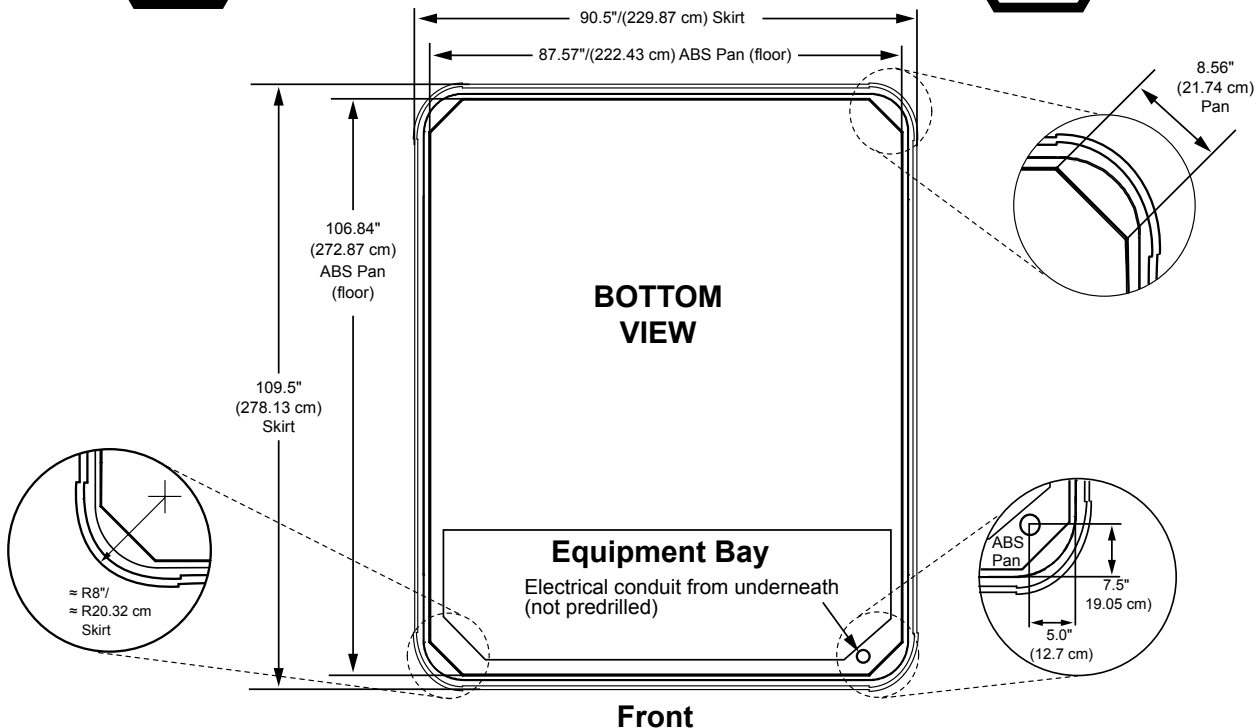

Dimensions/specifications subject to change without notice. Tolerance: $\pm 0.5"$ (1.27 cm)

Dimensions/Specifications Subject To Change Without Notice

SunSide Dimensions

Spa Models	DIMENSIONS A-F (All measurements are an approximate)					
	A	B	C* *±0.25" (0.635 cm)	D	E	F
Maxxus	41.5" (105.41 cm)	19.0" (48.26 cm)	5.5" (13.97 cm)	13.0" (33.02 cm)	32.5" (82.55 cm)	73.5" (186.69 cm)
Aspen						
Optima	37.5" (95.25 cm)		3.75" (9.53 cm)	10.75" (27.31 cm)	32.25" (81.92 cm)	71.5" (181.61 cm)
Cameo						63.25" (160.65 cm)
Altamar						58.25" (147.95 cm)
Marin	34" (86.36 cm)			10.25" (26.04 cm)	28.75" (73.03 cm)	58.25" (147.95 cm)
Capri	30.5" (77.47 cm)		3.5" (8.89 cm)	9.5" (24.13 cm)	25.5" (64.77 cm)	64.25" (163.19 cm)
DIMENSIONS G-I (All measurements are an approximate)						
	G	H	I	 <p>IMPORTANT! Always measure each hot tub for exact dimensions BEFORE designing its foundation support and/or decking.</p>		
Maxxus	8.0" (20.32 cm)	13.0" (33.02 cm)	3.5" (8.89 cm)			
Aspen						
Optima	7.0" (17.78 cm)	13.5" (34.29 cm)	1.5" (3.81 cm)			
Cameo						
Altamar						
Marin	6.5" (16.51 cm)	13.0" (33.02 cm)				
Capri	4.0" (10.16 cm)	14.5" (36.86 cm)				
- Dimensions Subject to Change Without Notice - Tolerance: ± 0.5" (1.27 cm)						

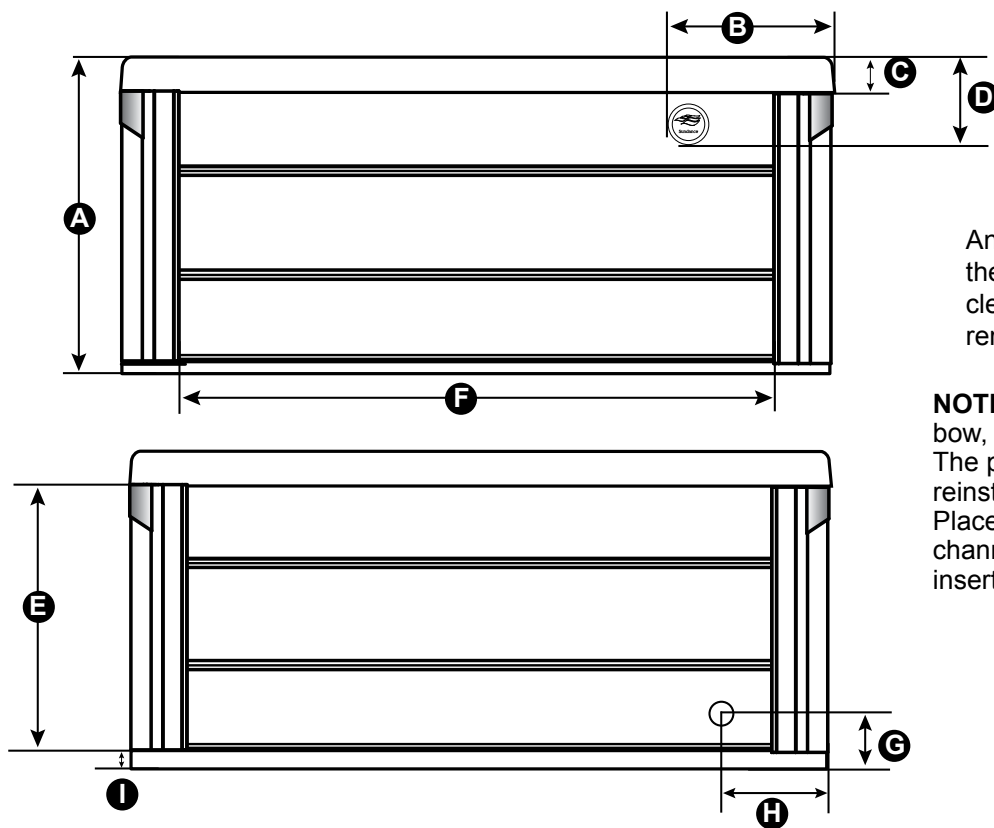

An 18" clearance, all around the spa, is recommended. This clearance is needed for panel removal or when servicing.

NOTE: Over time the panel(s) may bow, this is considered normal. The panels will straighten out when reinstalled into the mounting channel. Place one end of the panel into the channel first then flatten the panel and insert the other end.

Tolerance: ± 0.5" (1.27 cm)

Dimensions/Specifications Subject To Change Without Notice

Denne modellen kan kobles med 1-fas 230V C-sikring (treg) og 3-fas (400 volt TN-nett - se egne linjer)

880-serien:

For å få mest glede av badet anbefaler vi høyeste mulige kurs.				
Aspen	Type varmeelement	Alternativ tilkobling	Funksjon	Kretskortinnstillinger
Aspen	5,5kW	3-fas (400 volt TN-nett) 25 amp	Varmeelementet, 3 massasjepumper og luftpumpen kan driftes samtidig.	Se brukermanual.
Aspen	5,5 kW	25 + 32 amp	Varmeelementet, 3 massasjepumper og luftpumpen kan driftes samtidig.	Se brukermanual.
Aspen	5,5kW	25 + 25 amp	Varmeelementet og 3 massasjepumper kan driftes samtidig. Eventuelt varmeelementet, 2 massasjepumper og luftpumpen.	Se brukermanual.
Aspen	5,5 kW	40 amp	Varmeelement og 1 massasjepumpe driftes samtidig. Eventuelt alle pumper.	Se brukermanual.
Aspen	5,5 kW	32 amp	Varmeelementet slår seg av når massasjepumpene eller luftpumpen startes. 3 massasjepumper og luftpumpen kan driftes samtidig.	Se brukermanual.